

EM-1000 Series Meter Quickstart Guide

Code No. LIT-12011868

Issued July 21, 2014

Mechanical Installation **NOTE:** Do not overtighten nuts. The maximum installation torque is 0.4 Newton-Meter.

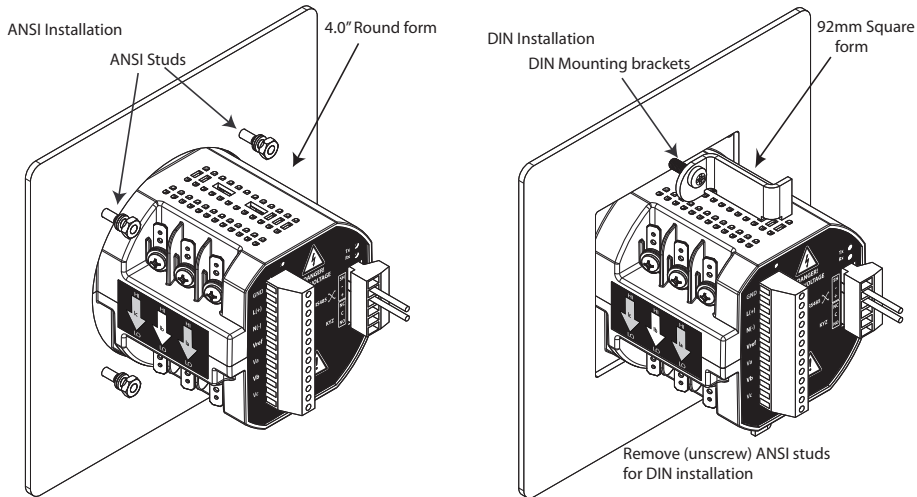

Electrical Installation: Select diagram to meet your application.

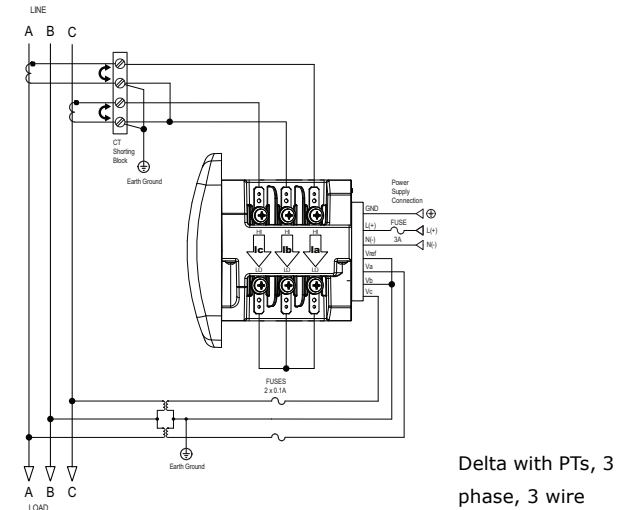
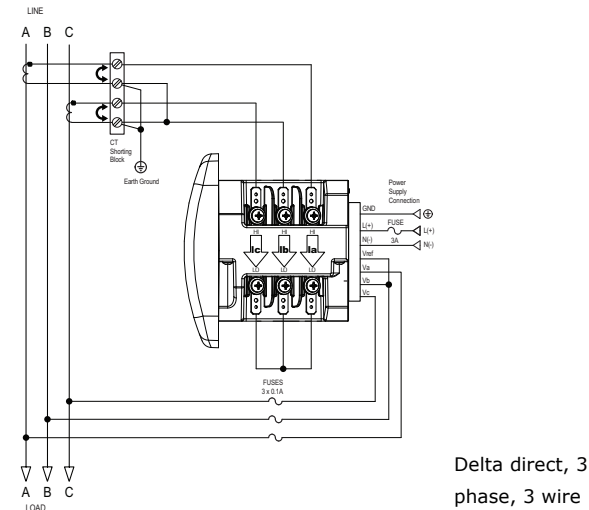
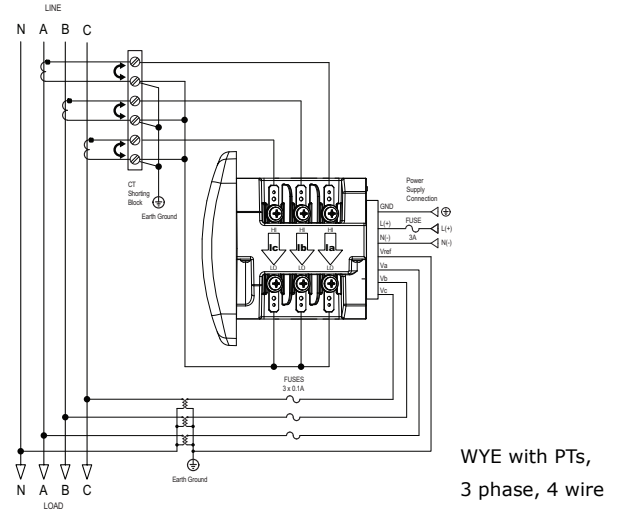
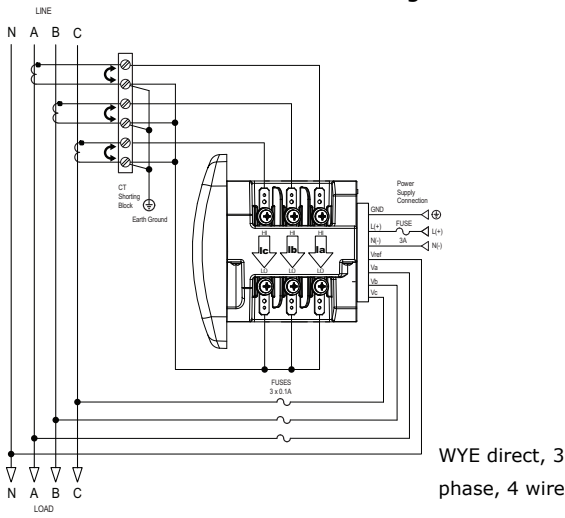

NOTE: Other wiring configurations are available. See the full Manual on the enclosed CD.

**Program Settings Using the Faceplate Buttons:
(MENU, ENTER, DOWN ARROW, RIGHT ARROW)**

See the figure on the right for the location of the faceplate buttons.

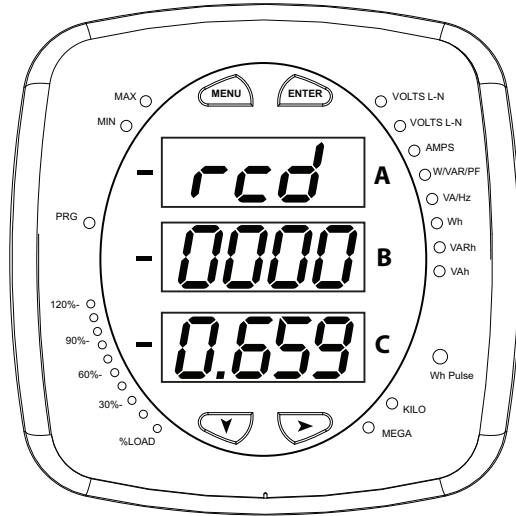

Access Configuration Mode:

1. Push the **MENU** button - you will see the display on the right; rSt will be blinking.

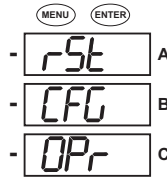

2. Press the **DOWN ARROW** once. CFG (Configuration) moves to the top of the display.

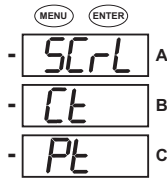

3. Press the **ENTER** button. You will see the Configuration menu, shown on the right.

4. Press the **DOWN ARROW** and then press the **ENTER** button. You will see the CT numerator setting screen (Ct-n). The current CT numerator is shown in the second line. To change the setting, press the **DOWN ARROW** until the value you want is displayed. Then press the **RIGHT ARROW** to move to the next digit. Repeat until the setting is done.

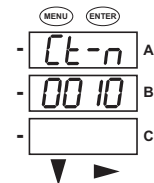

5. Press the **ENTER** button to go to the CT denominator screen (CT-d). This setting is display only - it can't be changed.

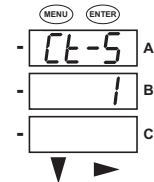

6. Press the **ENTER** button to go to the CT Scaling setting screen (CT-S). The current Scaling is shown in the second line. Press the **DOWN ARROW** to choose another value. You can choose 1, 10, or 100.

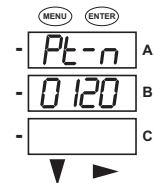

7. Press the **ENTER** button to go to the PT numerator setting screen (Pt-n). The current PT numerator is shown in the second line. To change the setting, press the **DOWN ARROW** until the value you want is displayed. Then press the **RIGHT ARROW** to move to the next digit. Repeat until the setting is done.

8. Press the **ENTER** button to go to the PT-denominator screen (Pt-d). The current PT denominator is shown in the second line. To change the setting, press the **DOWN ARROW** until the value you want is displayed. Then press the **RIGHT ARROW** to move to the next digit. Repeat until the setting is done.

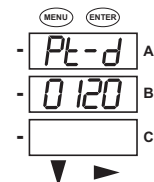

9. Press the **ENTER** button to go to the PT Scaling setting screen (PT-S). The current Scaling is shown in the second line. Press the **DOWN ARROW** to choose another value. You can choose 1, 10, 100, or 1000.

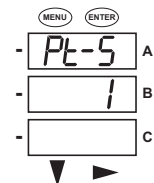

NOTE: See example CT and PT Settings on the next page.

10. Press the **ENTER** button to go to the Connection setting screen (Cnct). The current setting is shown in the second line. Press the **DOWN ARROW** to choose another value. You can choose 3 EL (element) WYE, 2 Ct del (Delta), or 2.5 EL WYE.

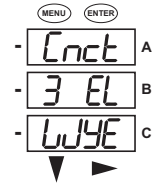

11. Press the **ENTER** button to go to the meter Address setting screen (Adr). The meter's current address is shown in the second line. To change the setting, press the **DOWN ARROW** until the value you want is displayed. Then press the **RIGHT ARROW** to move to the next digit. Repeat until the setting is done. Valid addresses are from 001 through 247.

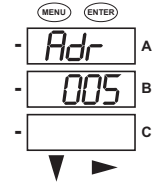

12. Press the **ENTER** button to go to the meter Baud Rate setting screen (bAUd). The meter's current Baud Rate is shown in the second line. Press the **DOWN ARROW** to choose another Baud Rate. If you have the RS485 Option, choose 9600.

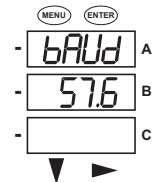

13. Press the **ENTER** button to go to the meter Protocol setting screen (Prot). The meter's current Protocol is shown in the second and third lines. Press the **DOWN ARROW** to choose another communication Protocol. If you have the RS485 Option, choose Mod rtU (Modbus RTU).

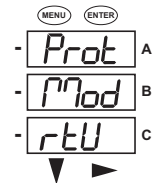

14. Press the **ENTER** button to go to the Scroll setting screen (SCrL). The current setting is shown in the second line. Press the **DOWN ARROW** to choose another setting. You can choose YES (the meter readings will scroll on the display) or no (the meter readings will not scroll on the display).

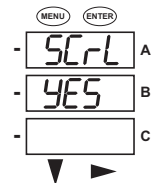

15. Press the **MENU** button twice. You will see the Store Settings screen (Stor ALL?). The default setting is YES. To save the settings you've made, press the **ENTER** button. You will see the confirmation screen (Stor ALL done) and then the meter resets.



NOTE: If you do not want to save your settings, press the **RIGHT ARROW**. YES changes to no. Press the **ENTER** button.



Example CT Settings:

- 200/5 Amps: set the Ct-n value as 200, Ct-S value as 1.
- 800/5Amps: set the Ct-n value as 800, Ct-S value as 1.
- 2000/5 Amps: set the Ct-n value as 2000, Ct-S value as 1
- 10,000/5 Amps: set the Ct-n value as 1000, Ct-S value as 10.

Example PT Settings:

- 14400/120 Volts: set the Pt-n value as 14400, Pt-d value as 120, Pt-S value as 10.
- 138000/69 Volts: set the Pt-n value as 1380, Pt-d value as 69, Pt-S value as 100.
- 345000/115 Volts: set the Pt-n value as 3450, Pt-d value as 115, Pt-S value as 100.
- 345000/69 Volts: set the Pt-n value as 345, Pt-d value as 69, Pt-S value as 1000.

Refer to the EM-1000/EM-2000 Series Meters' Installation and Operation Manual (LIT-12011867) for important product application information. Also refer to the manual for additional wiring options and programming information. The manual is on the enclosed CD.

This page intentionally left blank.